



# GUITAR MULTIPLE EFFECTS

5 SPECIAL SELECTED EFFECTS FOR GUITARISTS

## BE-5

Owner's Manual

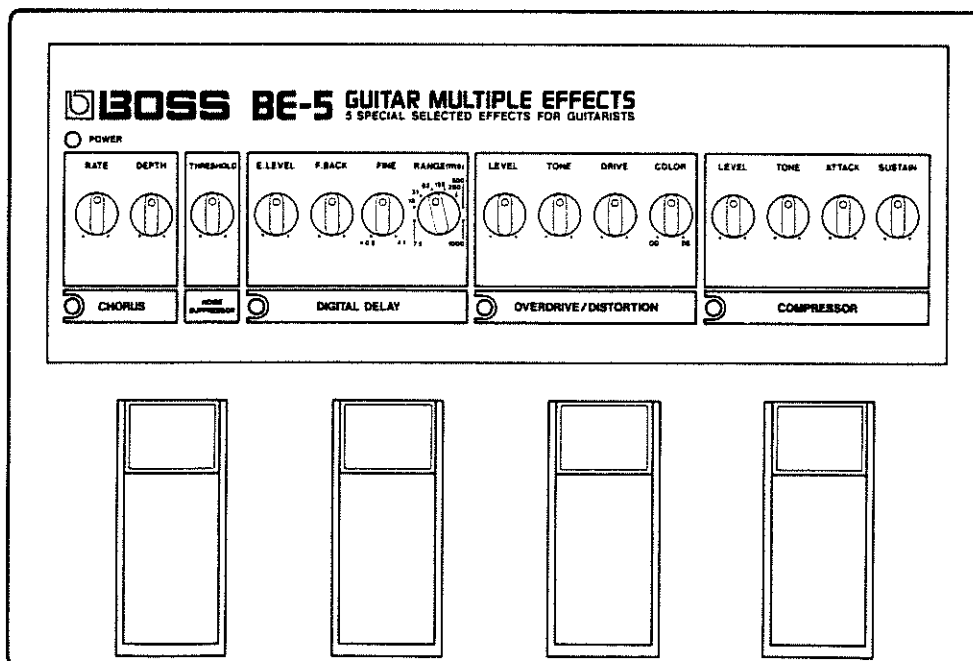

Thank you for purchasing the BOSS Guitar Multiple Effects BE-5. The BE-5 is a pedal type effect unit that contains five different effect units. Please read this instructions carefully.

## FEATURES

- The BE-5 contains five different built-in effect units, and therefore can be used without connecting the effect units using cables.
- The Overdrive/Distortion allows you to mix two different effect sounds for creation of wide variety of effect sounds.
- Provided with Send/Return Jacks, the BE-5 allows you to setup an effect or foot volume.
- By connecting a tuning unit to the Tuner Out Jack, tuning can be achieved even during live performance.

## CONNECTIONS

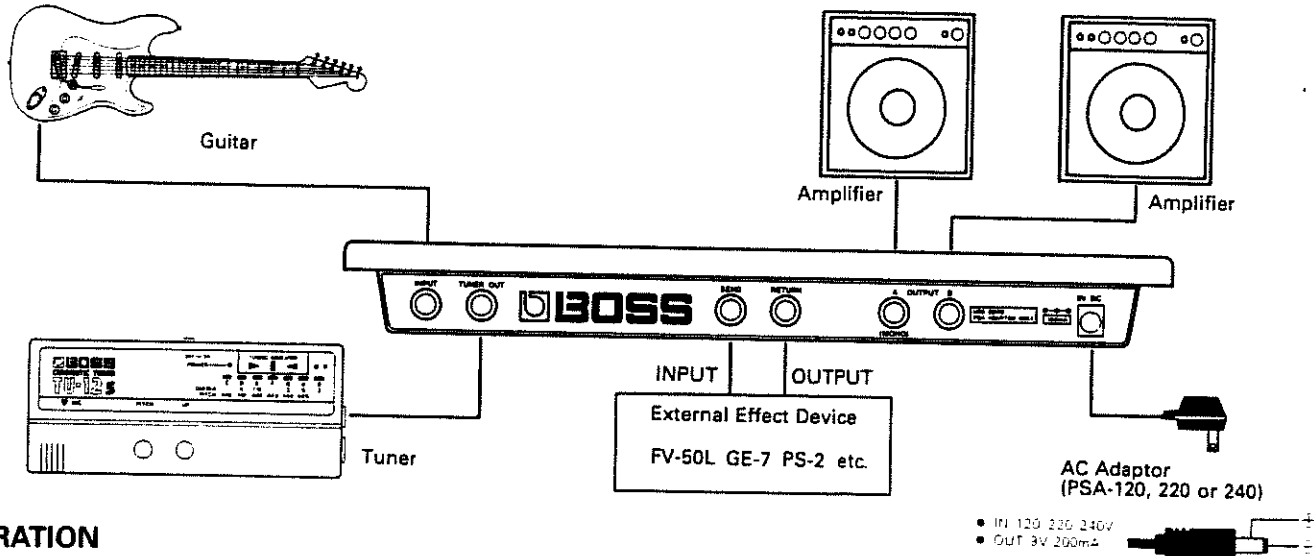

## OPERATION

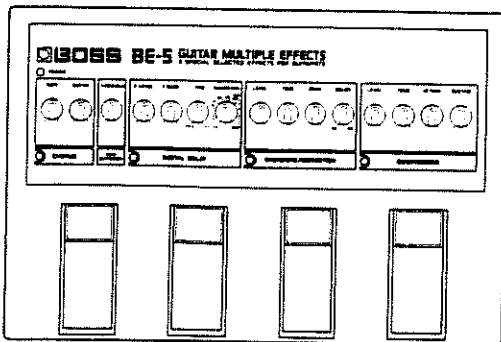
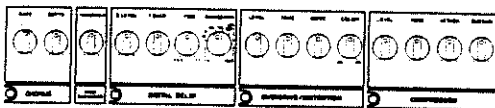

1 When you have connected the guitar and amplifier etc. as shown in "CONNECTIONS", connect the AC adaptor to the AC Adaptor Jack. Now, the Power Indicator lights up showing that the unit is ready to be used.

2 Set the control knobs as shown in "PANEL DESCRIPTION".

3 Set each effect unit:

① Turn the effect unit you wish to use with the pedal switch. (When the effect is turned on, the corresponding Effect Indicator lights up.)

\* Make sure that the other effects are turned off.

② Set the effect to your taste as explained in "PANEL DESCRIPTION" and "SETTING EXAMPLES".

③ Repeat the above procedure (steps ① and ②) for the rest of effects.

### Bescheinigung des Herstellers/Importeurs

Hiermit wird bescheinigt, daß der/die/das

**BOSS GUITAR MULTIPLE EFFECTS BE-5**

(Gerät/die Bescheinigung)

in Übereinstimmung mit den Bestimmungen der

**Amtsbl. Vfg 1046 1984**

(Anzeigebefugung)

funk-enstört ist

Der Deutschen Bundespost wurde das Inverkehrbringen dieses Gerätes angezeigt und die Berechtigung zur Überprüfung der Serie auf Einhaltung der Bestimmungen eingeräumt

**Roland Corporation Osaka Japan**

(Name des Herstellers/Importeurs)

### RADIO AND TELEVISION INTERFERENCE

**Warning** - This equipment has been verified to comply with the limits for a Class B computing device, pursuant to Subpart J, of Part 15, of FCC rules. Operation with non-certified or non-verified equipment is likely to result in interference to radio and TV reception.

The equipment described in this manual generates and uses radio-frequency energy. If it is not installed and used properly, that is, in strict accordance with our instructions, it may cause interference with radio and television reception.

This equipment has been tested and found to comply with the limits for a Class B computing device in accordance with the specifications in Subpart J, of Part 15 of FCC Rules. These rules are designed to provide reasonable protection against such interference in a residential installation. However, there is no guarantee that the interference will not occur in a particular installation. If this equipment does cause interference to radio or television reception, which can be determined by turning the equipment on and off, the user is encouraged to try to correct the interference by the following measure:

• Disconnect other devices and their input/output cables one at a time. If the interference stops, it is caused by either the other device or its I/O cable.

These devices usually require Roland designated shielded I/O cables. For Roland devices, you can obtain the proper shielded cable from your dealer. For non-Roland devices, contact the manufacturer or dealer for assistance.

If your equipment does cause interference to radio or television reception, you can try to correct the interference by using one or more of the following measures:

- Turn the TV or radio antenna until the interference stops.
- Move the equipment to one side or the other of the TV or radio.
- Move the equipment farther away from the TV or radio.
- Plug the equipment into an outlet that is on a different circuit than the TV or radio. (That is, make certain the equipment and the radio or television set are on circuits controlled by different circuit breakers or fuses.)
- Consider installing a rooftop television antenna with coaxial cable lead-in between the antenna and TV.

If necessary, you should consult your dealer or an experienced radio-television technician for additional suggestions. You may find helpful the following booklet prepared by the Federal Communications Commission:

"How to Identify and Resolve Radio-TV Interference Problems." This booklet is available from the U.S. Government Printing Office, Washington, D.C. 20402. Stock No. 004-001-90345-4.

## ■ PANEL DESCRIPTION

**Chorus**

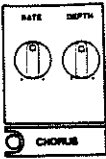

This creates rich and spacious chorus sounds.

**① Depth Control Knob**  
This sets the depth of the chorus effect.

(⌚): The chorus effect is made deeper.  
(⌚): The chorus effect is made weaker.

**② Rate Control Knob**  
This sets the rate of the chorus effect.

(⌚): The chorus effect is made quicker and deeper.  
(⌚): The chorus effect is made slower and weaker.

**Noise Suppressor**



This cuts the noise or hum that may be heard at break or interval between songs. When the guitar sound becomes lower than the set level (threshold level), this effect starts working.

**① Threshold Level Knob**  
This sets the threshold level where the noise suppressor is activated. Adjust this depending on the input and noise levels.

(⌚): The threshold level is set higher.  
(⌚): The threshold level is set lower.

- When the noise is high, rotate the knob clockwise so that the decay will sound natural.
- If the threshold level is set higher and the guitar's volume lower, the noise suppressor may work, causing no sound to be output.

**Digital Delay**

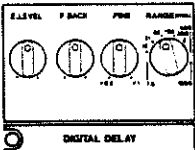

This adds slightly delayed sound to the actual guitar's sound, making richer sound. It also can create special effects. The BE-5 adopts the digital delay, so that delay effect can be obtained without deteriorating the sound quality from 3.8 to 1000 msec continuously.

**① Range Control Knob**  
This sets the delay time together with the Fine Control Knob. The Range Control Knob allows you to set the delay time in 8 levels.

(⌚): The delay time is made longer. Use this for long delay effect.  
(⌚): The delay time is made shorter. Use this for short delay effect.

**② Fine Control Knob**  
This finely adjusts the delay time set with Range Control Knob from  $\times 0.5$  to  $\times 1.0$ .

(⌚): The set delay time is made longer.  
(⌚): The set delay time is made shorter.

**③ Feedback Control Knob**  
This adjusts the amount of feedback.

(⌚): The amount of feedback is increased.  
(⌚): The amount of feedback is decreased. At the minimum position, single delay effect is created.

- Rotating this knob clockwise may cause oscillation.

**④ Effect Level Control Knob**  
This adjust the level of delay sound.

(⌚): The volume of delay sound is increased. At the maximum, the direct and delay sounds are equal.  
(⌚): The volume of delay sound is decreased. At the minimum, only the direct sound is output.

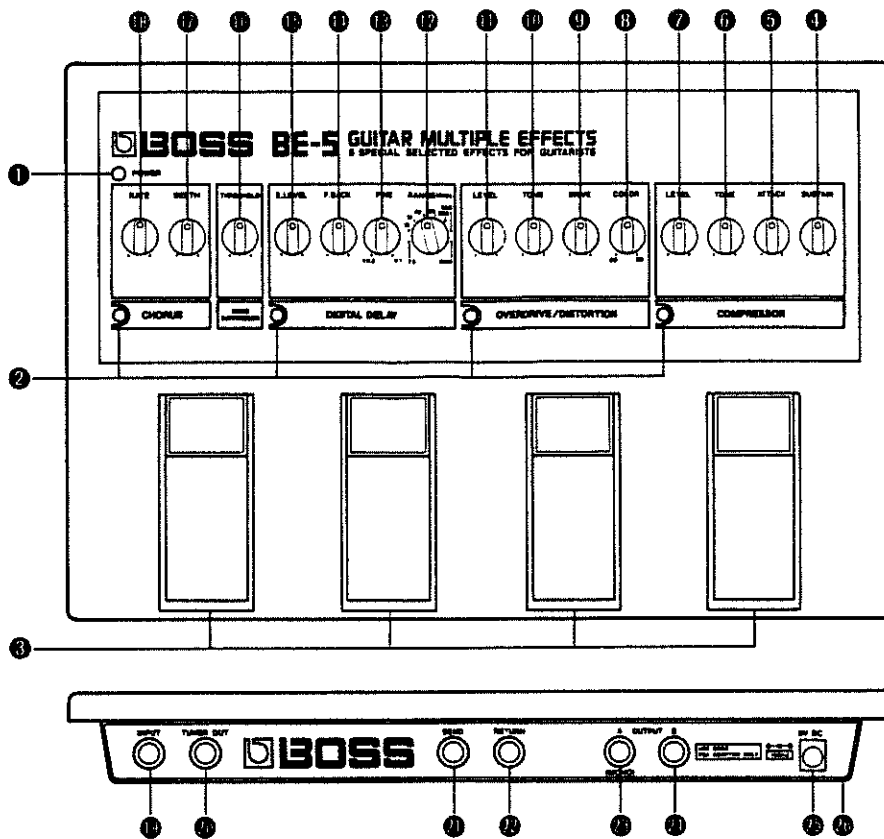

**21 Output Jack A (Monaural)**

**22 Output Jack B**

These are to connect to guitar amplifiers.

- When using only one guitar amplifier, connect it to the Output Jack A.
- When using two guitar amplifiers, the same signals are output from the Outputs A and B with chorus off, while with chorus on Output A sends chorus sound (pitch changed sound) that contains no normal sound and the Output B sends normal sound.

The BE-5 adopts the space compounding system, therefore, the chorus effect varies depending on the distance between the speakers. Please set the effect as you actually hear the sound.

**23 AC Adaptor Jack**

Connect an AC adaptor to this jack.

**24 Cord Hooker**

Attach the cord of the AC adaptor to the unit as shown in the picture to avoid disconnection of the adaptor plug.

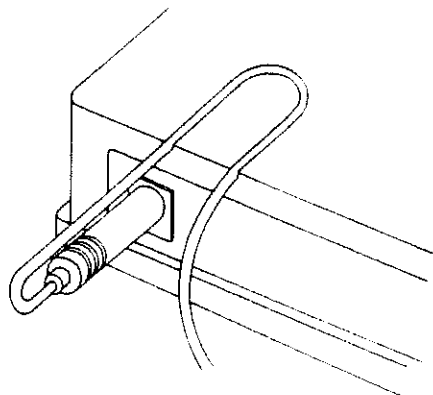

## Overdrive/Distortion

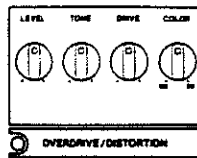

This effect creates overdrive or distortion which is essential for Rock or Heavy Metal sounds.

### 1 Color Control Knob

This BE-5 includes both overdrive and distortion effects. By adjusting the volume balance of these effect sounds, you can obtain single effect or mixed sounds.

[C]: Distortion sound is increased.

[C]: Overdrive sound is increased.

\* At the fully clockwise or counterclockwise position, only either of the effects is obtained.

### 2 Drive Control Knob

This controls the depth of the overdrive/distortion effect.

[C]: The distortion of sound is emphasized, resulting powerful sounds.

[C]: The distortion of sound is cut, resulting softer sounds.

### 3 Tone Control Knob

This controls tone of the overdrive/distortion sound.

[C]: Higher frequencies are emphasized, creating sharp sounds.

[C]: Higher frequencies are cut, creating soft sounds.

### 4 Level Control Knob

This adjusts the volume of overdrive or distortion sound. Adjust this knob so that there will be no volume difference between the effect and normal sounds.

[C]: Effect sound is increased.

[C]: Effect sound is decreased.

## Compressor

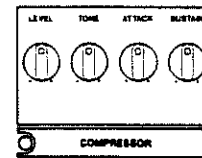

This effect cuts higher amplitude and boosts lower amplitude, for creating a long sustain effect without distorting the direct sounds.

### 1 Sustain Control Knob

This controls the sustained time of sound.

[C]: Sustained time of sound is made longer.

[C]: Sustained time of sound is made shorter. At its minimum position, the knob cuts the maximum input signal, working like a limiter.

### 2 Attack Control Knob

This controls the intensity of the picking attack.

[C]: Each note takes on attack even in quick performance, therefore sharp sound is created.

[C]: Picking attack is lowered.

### 3 Tone Control Knob

This controls tone of the guitar sounds.

[C]: Higher frequencies are emphasized, creating sharp sounds.

[C]: Higher frequencies are cut, creating soft sounds.

### 4 Level Control Knob

This controls the volume when the effect is on. Adjust this knob so that there will be no volume difference between the effect and normal sounds.

[C]: The level of effect sound is increased.

[C]: The level of effect sound is decreased.

### 1 Power Indicator

This lights up when the AC adaptor is plugged in the AC Adaptor Jack, showing that the unit is ready to be used.

### 2 Effect Indicators

This lights up when the corresponding effect is turned on, and therefore can be used as an on/off indicator of each effect.

### 3 Pedal Switch

Pressing the pedal turns on or off the effect.

### 19 Input Jack

Connect a guitar to this jack.

### 20 Tuner Output Jack

The Tuner Output Jack sends guitar signals for tuning constantly. Connect a tuning unit so that you can achieve tuning at any time

### 21 Send Jack

### 22 Return Jack

By connecting an external device such as an effect, an additional function can be set between the overdrive/distortion and digital delay.

\* How to set up an external device is shown in "CONNECTIONS"

### [Setup Examples]

The following shows how to set up a unit to the Send/Return jacks

- Connect a foot volume (FV-50L)

The foot volume is connected pre digital delay for creating natural decay with remaining delay in violin performance

- Connect an equalizer (GE-7)

The equalizer allows you to change the tone of sound

- Connect a pitch shifter (PS-2)

By adding a sound of shifted pitch, you can obtain such effect as two guitars are playing

# SETTING EXAMPLES

## • Long Delay Lead Sound

RATE DEPTH		THRESHOLD	E.LEVEL F.BACK FINE RANGE(mHz)				LEVEL TONE DRIVE COLOR	LEVEL TONE ATTACK SUSTAIN						
<input type="checkbox"/> CHORUS		<input type="checkbox"/> NOISE SUPPRESSOR	<input checked="" type="checkbox"/> DIGITAL DELAY				<input checked="" type="checkbox"/> OVERDRIVE/DISTORTION				<input type="checkbox"/> COMPRESSOR			

## • Long Sustained Lead Sound

RATE DEPTH		THRESHOLD	E.LEVEL F.BACK FINE RANGE(mHz)				LEVEL TONE DRIVE COLOR	LEVEL TONE ATTACK SUSTAIN						
<input type="checkbox"/> CHORUS		<input type="checkbox"/> NOISE SUPPRESSOR	<input type="checkbox"/> DIGITAL DELAY				<input checked="" type="checkbox"/> OVERDRIVE/DISTORTION				<input checked="" type="checkbox"/> COMPRESSOR			

## • Solid Lead Sound

RATE DEPTH		THRESHOLD	E.LEVEL F.BACK FINE RANGE(mHz)				LEVEL TONE DRIVE COLOR	LEVEL TONE ATTACK SUSTAIN						
<input checked="" type="checkbox"/> CHORUS		<input type="checkbox"/> NOISE SUPPRESSOR	<input checked="" type="checkbox"/> DIGITAL DELAY				<input checked="" type="checkbox"/> OVERDRIVE/DISTORTION				<input type="checkbox"/> COMPRESSOR			

## • Lead Sound without distortion

RATE DEPTH		THRESHOLD	E.LEVEL F.BACK FINE RANGE(mHz)				LEVEL TONE DRIVE COLOR	LEVEL TONE ATTACK SUSTAIN						
<input checked="" type="checkbox"/> CHORUS		<input type="checkbox"/> NOISE SUPPRESSOR	<input checked="" type="checkbox"/> DIGITAL DELAY				<input type="checkbox"/> OVERDRIVE/DISTORTION				<input checked="" type="checkbox"/> COMPRESSOR			

## • Cutting Sound

RATE DEPTH		THRESHOLD	E.LEVEL F.BACK FINE RANGE(mHz)				LEVEL TONE DRIVE COLOR	LEVEL TONE ATTACK SUSTAIN						
<input checked="" type="checkbox"/> CHORUS		<input type="checkbox"/> NOISE SUPPRESSOR	<input checked="" type="checkbox"/> DIGITAL DELAY				<input type="checkbox"/> OVERDRIVE/DISTORTION				<input checked="" type="checkbox"/> COMPRESSOR			

## IMPORTANT NOTES

- Be sure to use the supplied AC adaptor (PSA-120/-220/-240).
- The appropriate power supply for this unit is shown on its name plate. Please make sure that the line voltage in your country meets the requirements.
- Do not use the same socket used for any noise generating device. (such as a motor or variable lighting system.)
- When disconnecting the power plug from the socket, do not pull the cord but hold the plug to avoid damaging the cord.
- Avoid damaging the power cord.
- If the unit is not to be used for a long period of time, unplug the cord from the socket.
- Before setting up this BE-5 with other devices, turn this unit off along with all other units.
- Avoid using this device in excessive heat or humidity conditions, or where it may be affected by direct sunlight or dust and avoid places subject to high vibration.
- Operating the unit near a neon light, fluorescent lamp, TV or CRT Display may cause noise interference. If so, change the angle or the position of the unit.

- Do not place or drop anything heavy on the main unit or its power cord.
- For cleaning the unit, use a dry and soft cloth.
- If the casing is stained, use a cloth slightly dampened with water.
- To remove stubborn stains, clean the casing with a cloth moistened with a neutral detergent, then wipe it dry with a soft cloth.
- Do not use solvents such as paint thinner when cleaning.
- Adjust the volume control to a level that will not disturb the neighborhood, especially at night when sounds can travel over long distance.
- Do not allow fluid or foreign matter, such as water, beverages, coins and wires, to enter this unit.
- Do not examine or modify the internal components or circuitry. Electrical shocks or damage may result.
- Do not subject this unit to strong shocks, or move it while the power is on.
- If this unit fails to operate correctly, turn it off immediately and contact your Roland dealer.

## SPECIFICATIONS

### CONTROLS

- ① **Compressor**  
Sustain, Attack, Tone, Level
- ② **Overdrive/Distortion**  
Color, Drive, Tone, Level
- ③ **Digital Delay**  
Range, Fine, Feedback, Effect Level
- ④ **Noise Suppressor**  
Threshold Level
- ⑤ **Chorus**  
Depth, Rate

### SWITCHES

Pedal × 4

### INDICATORS

Effect × 4  
Power × 1

### JACKS

Input, Output A (Monaural), Output B,  
Tuner Output, Send, Return

### ELECTRICAL CHARACTERISTICS

- **Input**  
Rated Input Level: -20dBm  
Input Impedance: 1M $\Omega$
- **Tuner Output**  
Rated Output Level: -20dBm  
Output Impedance: 2k $\Omega$   
Output Load Impedance: More than 20k $\Omega$
- **Effect Send**  
Rated Output Level: -20dBm  
Output Impedance: 1k $\Omega$   
Output Load Impedance: More than 10k $\Omega$
- **Effect Return**  
Rated Input Level: -20dBm  
Input Impedance: 47k $\Omega$
- **Digital Delay**  
System: 12 bit (8 bit at 1000ms range)  
equivalent analog logarithm  
compression  
Delay Time: 3.8 to 1000 msec  
Frequency Response: Delay = 20Hz  
to 15kHz ( $\pm 3$ dB)  
Residual Noise: Less than -90dBm  
(IHF-A) (at  $\times 0.5$ )

### Chorus

Frequency Response: 30Hz to 13kHz  
( $\pm 3$ dB)  
Residual Noise: Less than -90dBm  
(IHF-A)

**Power:** 9VDC (AC Adaptor PSA-120, 220 or 240)

**Current Draw:** 150mA (maximum)

**Dimensions:** 300(W) × 40(H) × 200(D)mm  
11-3/4" × 1-9/16" × 7-7/8"

**Weight:** 950g/2lb 2oz (without AC Adaptor)

**Accessories:** Owner's Manual

**Options:** Chromatic Tuner (TU-12, TU-12S)  
Foot Volume (FV-50L)  
Equalizer (GE-7)  
Pitch Shifter (PS-2)

\* Specifications are subject to change without notice.

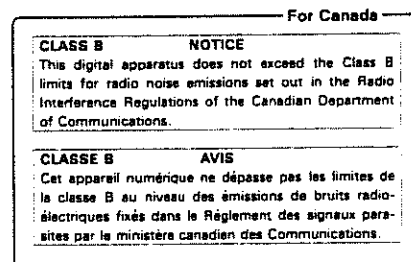

## BLOCK DIAGRAM

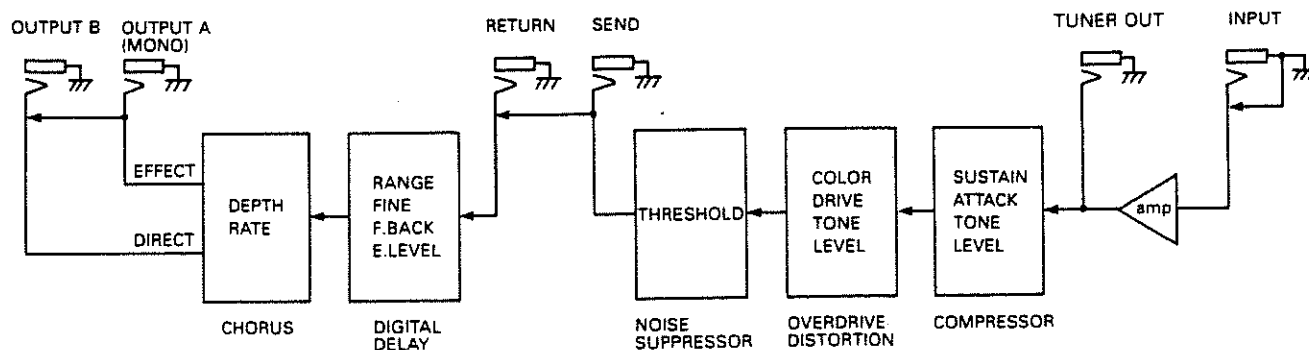

**BOSS**  
Products of Roland

Printed in Japan Jan. '89 E-3

**Roland®**

---

**2603059200**

UPC

2603059200



1845

** BOSS**